

Encoder 11mm Size Metal Shaft Type

EC11 Series

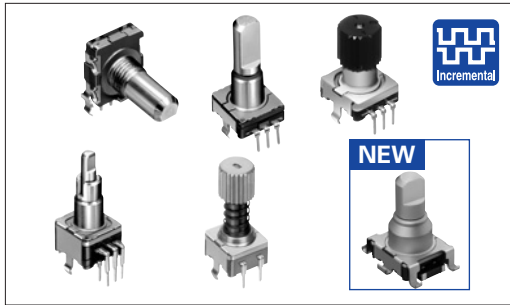

Compact and highly reliable type available in many varieties.



Features

- Compact and highly accurate sliding contact type encoder.
- 1.5mm-travel push switch with compliance to 4.5mm height.
- Incremental type.
- Operation life 1,000,000cycles can be supported (EC11J).

Applications

- For controlling volume in car AV equipment, volume and menu selection in car navigation systems and various in-car components where less mounting surface is required
- For various types of controlling in DVD players/recorders, mini component stereos, CD players, portable audio players and various AV equipment
- For home appliances (microwave ovens)

Typical Specifications

Items	Specifications
Rating	10mA 5V DC
Operating life	15,000cycles EC11J:100,000cycles / 500,000cycles / 1,000,000cycles

Product Line

Structure	Actuator configuration	Actuator length (mm)	Torque (mN·m)	Number of detent	Number of pulse	Push-on switch	Travel of push-on switch (mm)	Operating life (cycles)	Minimum packing unit (pcs.)	Product No.	Drawing No.			
Horizontal			12±7	30	15	Without	—	15,000	700	EC11B15202AA	1			
						With	0.5			EC11B15242AE	2			
							1.5			EC11B15242AF	3			
Vertical	Flat	20	10±7	18	9	Without	—	15,000	1,200	EC11E09204A4	4			
				30	15					EC11E15204A3				
			7 ⁺³ / ₋₄	Without	—	EC11E1530401								
			10±7	36	18	EC11E1820402								
			7 ⁺³ / ₋₄	Without	18	EC11E1830401								
			With	10±7	18	9	0.5			15,000	1,200	EC11E09244BS	5	
					30	15						EC11E15244G1		
				7 ⁺³ / ₋₄	Without	—						EC11E153440D		
				10±7	36	18						EC11E18244AU		
				7 ⁺³ / ₋₄	Without	18						EC11E183440C		
				10±7	18	9						1.5		EC11E09244AQ
					30	15								EC11E15244B2
				7 ⁺³ / ₋₄	Without	—						EC11E1534408		
				10±7	36	18						EC11E18244A5		
			7 ⁺³ / ₋₄	Without	—	EC11E1834403								

Detector

Push

Slide

Rotary

Encoders

Power

Dual-in-line
Package Type

Multi Control
Devices

TACT Switch™

Custom-
Products

Incremental
Type

Absolute
Type

Product Line

Structure	Actuator configuration	Actuator length (mm)	Torque (mN·m)	Number of detent	Number of pulse	Push-on switch	Travel of push-on switch (mm)	Operating life (cycles)	Minimum packing unit (pcs.)	Product No.	Drawing No.													
Detector	Less shaft wobble	20-tooth serration	18	10±7	30	With	1.5	15,000	1,200	EC11G1524402	6													
				7 ⁺³ ₋₄	Without					15		EC11G1534403												
Push	Reflow	Flat	20	12±5	18	9	Without	—	100,000	300	EC11J0920401	7												
Slide					30	15					EC11J1520401													
Rotary					18	9	With	0.5			EC11J0924401	8												
					30	15							EC11J1524401											
Encoders					18	9	With	1.5				EC11J0925401	8											
					30	15						EC11J1525401												
Power					18	9	Without	—			500,000	300	EC11J0920601	7										
					30	15							EC11J1520601											
Dual-in-line Package Type					TACT Switch™	Flat	20	12±5	18		9	With	0.5	500,000	300	EC11J924601	8							
Multi Control Devices									30		15					EC11J1524601								
Custom-Products									18		9	With	1.5			EC11J0925601	8							
									30		15					EC11J1525601								
Incremental Type									TACT Switch™		Flat	20	12±5			18	9	Without	—	1,000,000	300	EC11J0920801	7	
																30	15					EC11J1520801		
																Absolute Type	18	9	With			0.5	EC11J092481	8
																	30	15					EC11J1524801	
Absolute Type	TACT Switch™	Flat	20	12±5	18	9	With	1.5	1,000,000	300	EC11J0925801	8												
					30	15					EC11J1525801													
Push lock	20-tooth serration	25	10±7	30	15	Without	—	15,000	1,000	EC11E152T409	9													
		26.4				With	8		800	EC11E152U402	10													
Self-return switch	Flat	20	3 to 30	Without	Self-return switch	Without	—	15,000	1,200	EC1110120001	11													
						With	0.5			EC111012010H	12													
Dual-shaft	Flat	Inner-shaft=25	10±7	30	15	Without	—			700		EC1110120201	13											
											With	1.5		EC11EBB24C03										
Dual-shaft	Slotted	Outer-shaft=15	10±7	30	15	Without	—	700	700	EC11E0B2LB01	14													
												Flat	Inner-shaft=25	3 to 30	Without	Self-return switch	Without	—						

Note

Products other than those listed in the above chart are also available. Please contact us for details.







Refer to P.190 for product varieties.
Refer to P.194,195 for product specifications.
Refer to P.236 for attached parts.

- Detector
- Push
- Slide
- Rotary
- Encoders
- Power
- Dual-in-line Package Type
- Multi Control Devices
- TACT Switch™
- Custom-Products
- Incremental Type
- Absolute Type

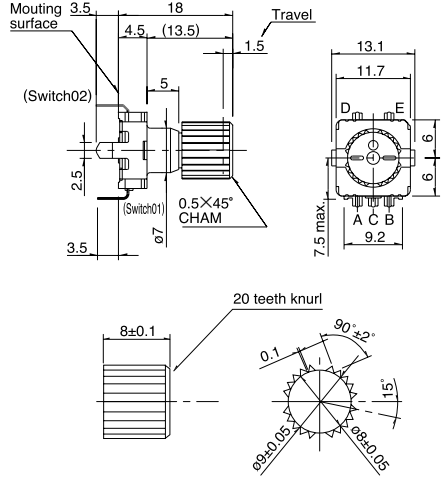
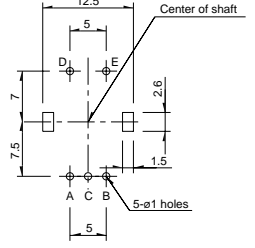
■ Dimensions				Unit:mm
No.	Photo	Style	PC board mounting hole dimensions (Viewed from mounting side)	
1				
2				
3				
4				
5				

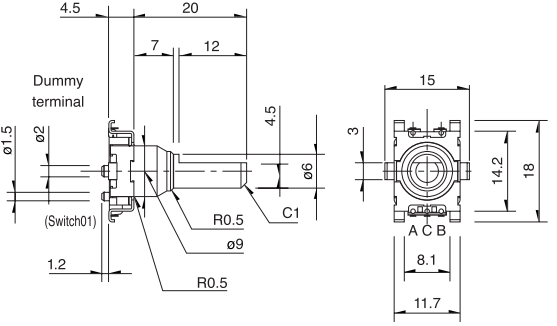
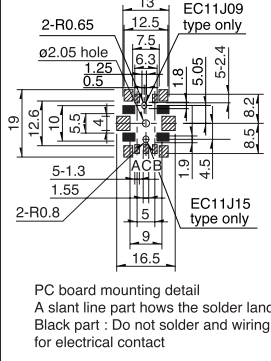

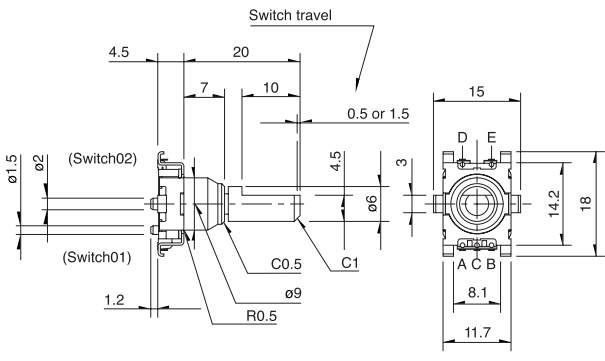
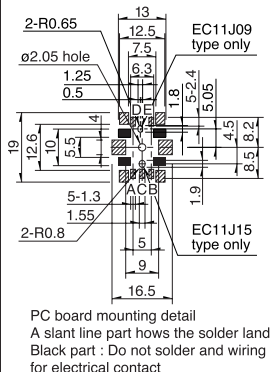

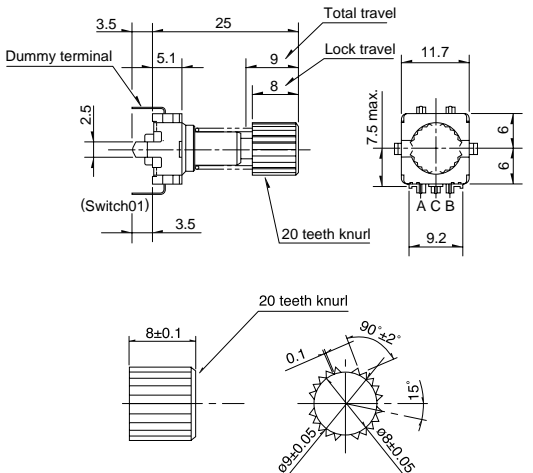
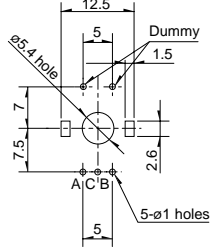

Dimensions

Unit:mm

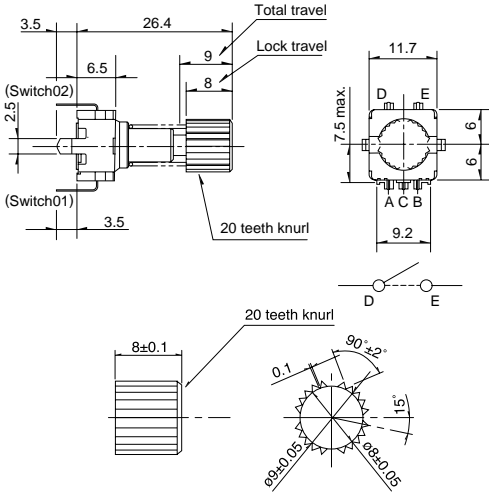
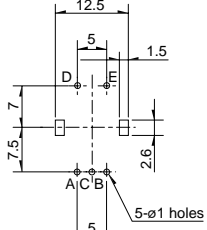
No.	Photo	Style	PC board mounting hole dimensions (Viewed from mounting side)
6	<p>Less shaft wobble with push-on switch (travel 1.5mm)</p> 		
7	<p>Reflow applicable parts</p> 		 <p>PC board mounting detail A slant line part shows the solder land Black part : Do not solder and wiring for electrical contact</p>
8	<p>Reflow applicable parts with push-on switch (travel 0.5/1.5mm)</p> 		 <p>PC board mounting detail A slant line part shows the solder land Black part : Do not solder and wiring for electrical contact</p>
9	<p>Push-lock mechanism</p> 		

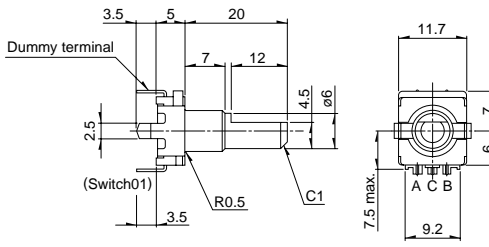
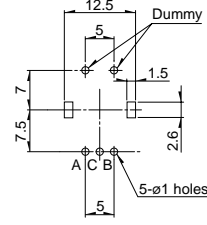
Dimensions

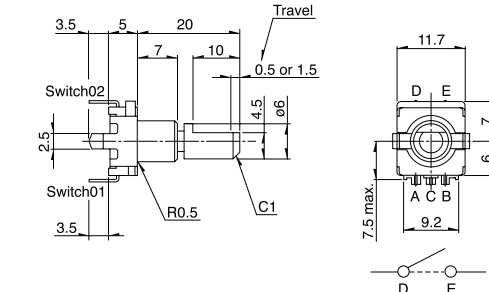
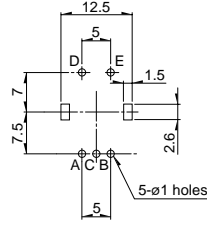
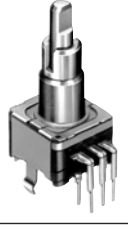
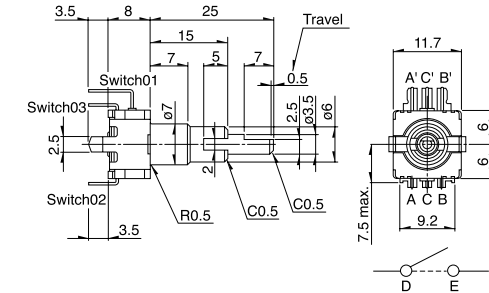
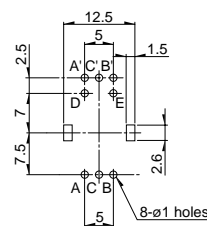
Unit:mm

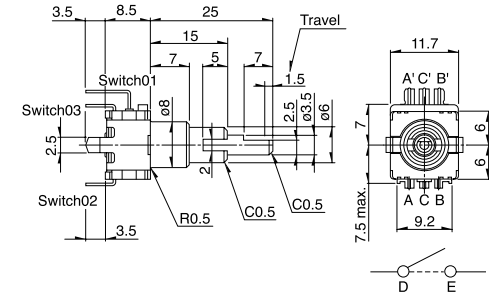
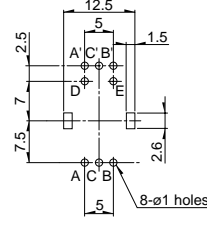
No.	Photo	Style	PC board mounting hole dimensions (Viewed from mounting side)
10	<p>Push-lock mechanism with push-lock switch</p> 		
11	<p>Self-return switch</p> 		
12	<p>Self-return switch with push-on switch (travel 0.5mm/1.5mm)</p> 		
13	<p>Dual-shaft type with push-on switch (travel 0.5mm) Inner shaft: encoder Outer shaft: encoder</p> 		
14	<p>Dual-shaft type with push-on switch (travel 1.5mm) Inner shaft: encoder Outer shaft: self-return switch</p> 		

Detector

Push

Slide

Rotary

Encoders

Power

Dual-in-line
 Package Type

Multi Control
 Devices

TACT Switch™

Custom-
 Products

Incremental
 Type

Absolute
 Type

Product Varieties

Shaft Dimensions

1. Single-shaft Type

1) Knurled Type

Unit:mm

Configuration (Shaft diameter : $\phi 6$)

Not applicable for EC11E and EC11G with push-lock mechanism

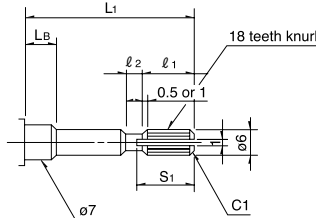

● Detailed dimensions

L ₁	L _B	l ₁	l ₂	S ₁
20	7	6	1	7
25	7	10	2	11

2) Flat Type

Unit:mm

Configuration (Shaft diameter : $\phi 6$)

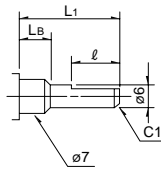

● Detailed dimensions

L ₁	L _B	l
15	5	7
15	7	5 (6)
20	7	10 (12)
25	7	12

※ Does not comply with EC111

Dimensions marked with () apply to products without push-on switches.

3) Slotted Type

Unit:mm

Configuration (Shaft diameter : $\phi 6$)

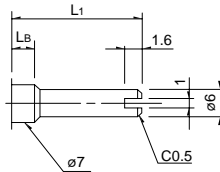

● Detailed dimensions

L ₁	L _B
15	7
20	7
25	7

2. Standard Dimensions and configuration of Dual-shaft Type

1) Flat Type

Unit:mm

Configuration (Inner-shaft : $\phi 3.5$ Outer-shaft : $\phi 6$)

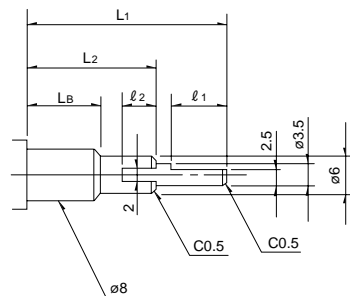

● Detailed dimensions

L ₁	L ₂	L _B	l ₁	l ₂
20	10	5	7	4
25	15	7	7	5
30	20	7	7	5

Notes

- The highlighted figures in shaft types refer to Product Specifications in P.194 and P.195.
- Products other than those listed in the above chart are also available. Please contact us for details

Product Specifications

Items		EC11B	EC11E/EC11G	EC11J	EC111	EC20A
Detector	Operating temperature range	-30°C to +85°C		-40°C to +85°C	-30°C to +85°C	-30°C to +80°C
	Maximum operating current (Resistive load)	10mA				0.5mA
Push	Rating	10mA 5V DC				0.5mA 5V DC
		Output of A and B signals, proportionate to phase difference			Self-return switch	Output of A and B signals, proportionate to phase difference
Slide	Output signal					
	Insulation resistance	100MΩ min. 250V DC				10MΩ min. 50V DC
Rotary	Voltage proof	300V AC for 1minute				50V AC for 1min.
	Rotational torque (without click feeling)	—	7 ⁺³ ₋₄ mN·m	—	3 to 30mN·m	—
Encoders	Detent torque	12±7mN·m	10±7mN·m	12±5mN·m	—	40±20mN·m
	Push-pull strength	100N				
Power	Resistance to soldering heat	Manual soldering	350°C max. 3s max.			
		Dip soldering	260±5°C, 5±1s	—	260±5°C, 5±1s	
		Reflow soldering	—	Please see P.235	—	
Dual-in-line Package Type	Rotational life	15,000cycles		100,000cycles	15,000cycles	30,000cycles
	Multi Control Devices					
TACT Switch™	Cold	-40±3°C for 240h				
		Dry heat	85±3°C for 240h			
			60±2°C, 90 to 95%RH for 240h			
Custom-Products	Damp heat					

Push-on Switch Specifications

Items	EC11B	EC11E/EC111/EC11G	EC11J	EC20A
Circuit · number of contacts	Single pole and single throw (Push-on)			
Travel (mm)	0.5 ^{+0.4} _{-0.3}	1.5±0.5	0.5±0.3	1.5±0.5
Operating force(N)	6±3	5±2	6 ^{+2.5} ₋₂	4±2
Rating	3A 16V DC (10mA 16V DC min. ratings)	0.5A 16V DC (1mA 16V DC min. ratings) 0.5A 12V DC ※	0.1A 5V DC	0.5A 16V DC (1mA 16V DC min. ratings)
Contact resistance	100mΩ for initial period; 200mΩ after rotational life			
Operating life	25,000 times min.	20,000times min. 10,000times min.※	1,000,000 times min.	100,000 times min. 20,000times min.

Note

※marked specification is only applicable to EC11E152U402.

Product Specifications

Output Wave

EC11B	EC11E/EC11G/EC11J	EC111	EC20A													
<p>EC11B, EC11E, EC11G 30 detents, 15 pulse</p> <p>A signal OFF ON B signal OFF ON</p> <p>Detent stability point CW direction</p>	<p>The stable detent position cannot be identified in phase B.</p> <p>EC11E 18 detents 9 pulse EC11G 36 detents 18 pulse EC11J</p> <p>A signal OFF ON B signal OFF ON</p> <p>Detent stability point CW direction</p>		<table border="1"> <thead> <tr> <th>Shaft rotational Direction</th> <th>Signal</th> <th>Output</th> </tr> </thead> <tbody> <tr> <td rowspan="2">Clockwise</td> <td>A (Terminal A-C)</td> <td>OFF ON ON OFF ON OFF ON</td> </tr> <tr> <td>B (Terminal B-C)</td> <td>OFF ON ON OFF ON OFF ON</td> </tr> <tr> <td rowspan="2">Counter-clockwise</td> <td>A (Terminal A-C)</td> <td>OFF ON ON OFF ON OFF ON</td> </tr> <tr> <td>B (Terminal B-C)</td> <td>OFF ON ON OFF ON OFF ON</td> </tr> </tbody> </table> <p>The dotted lines indicate detent positions</p>	Shaft rotational Direction	Signal	Output	Clockwise	A (Terminal A-C)	OFF ON ON OFF ON OFF ON	B (Terminal B-C)	OFF ON ON OFF ON OFF ON	Counter-clockwise	A (Terminal A-C)	OFF ON ON OFF ON OFF ON	B (Terminal B-C)	OFF ON ON OFF ON OFF ON
Shaft rotational Direction	Signal	Output														
Clockwise	A (Terminal A-C)	OFF ON ON OFF ON OFF ON														
	B (Terminal B-C)	OFF ON ON OFF ON OFF ON														
Counter-clockwise	A (Terminal A-C)	OFF ON ON OFF ON OFF ON														
	B (Terminal B-C)	OFF ON ON OFF ON OFF ON														

Sliding Noise

EC11B	EC11E/EC11G/EC11J	EC111	EC20A	
<p>$V_1=V_2=1.5V$ max.</p> <p>Test circuit: 5V DC, R, Terminal A, Terminal B, Encoder, Terminal C</p> <p>Output waveform: 5V, V1, V2, Sliding direction, ON OFF ON</p> <p>Measurement condition : Rotation speed 360°/s t : Masking time to avoid chattering</p>	<p>At R = 5kΩ Chattering : 2ms max. Bounce : 2ms max.</p>	<p>—</p>	<p>$V_1=V_2=1.5V$ max.</p> <p>Test circuit: 5V DC, R, Terminal A, Terminal B, Encoder, Terminal C</p> <p>Output waveform: 5V, V1, V2, Sliding direction, ON OFF ON</p> <p>Measurement condition : Rotation speed 360°/s t : Masking time to avoid chattering</p>	<p>At R = 5kΩ Chattering : 8ms max. Bounce : 5ms max.</p>

Detector

Push

Slide

Rotary

Encoders

Power

Dual-in-line Package Type

Multi Control Devices

TACT Switch™

Custom-Products

Incremental Type

Absolute Type

Soldering Conditions

Example of Reflow Soldering Condition

1. Heating method: Double heating method with infrared heater.
2. Temperature measurement: Thermocouple 0.1 to 0.2 ϕ CA (K) or CC (T) at soldering portion (copper foil surface). A heat resisting tape should be used for fixed measurement.
3. Temperature profile

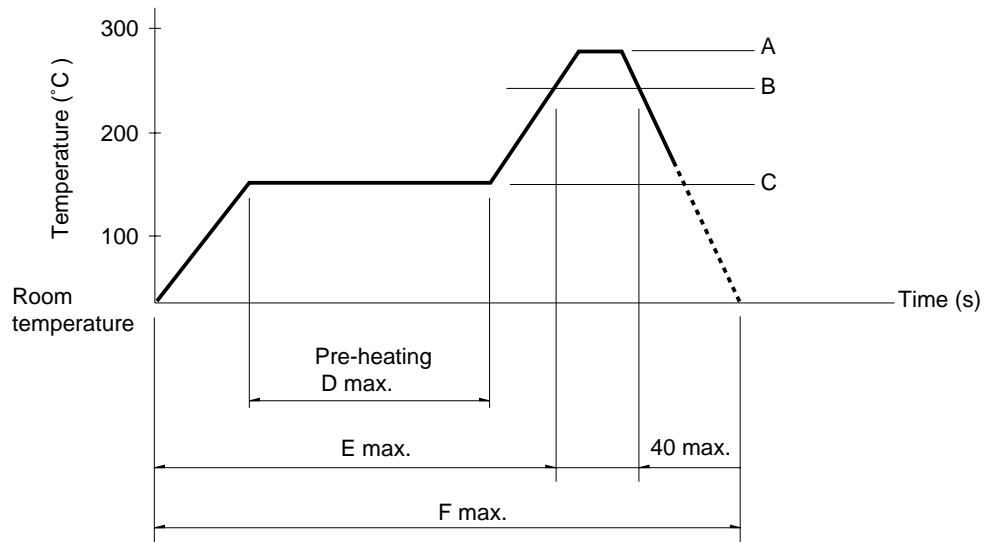

Series(Reflow type)	A (°C) 3s max.	B (°C)	C (°C)	D (s)	E (s)	F (s)
EC11J	260	230	150	120	—	240

Notes

1. The condition mentioned above is the temperature on the mounting surface of a PC board. There are cases where the PC board's temperature greatly differs from that of the switch, depending on the PC board's material, size, thickness, etc. The above-stated conditions shall also apply to switch surface temperatures.
2. Soldering conditions differ depending on reflow soldering machines. Prior verification of soldering condition is highly recommended.

Detector

Push

Slide

Rotary

Encoders

Power

Dual-in-line
Package TypeMulti Control
Devices

TACT Switch™

Custom-
ProductsIncremental
TypeAbsolute
Type

Attached Parts

The following parts are included with the product.

SRGH Series

Unit:mm

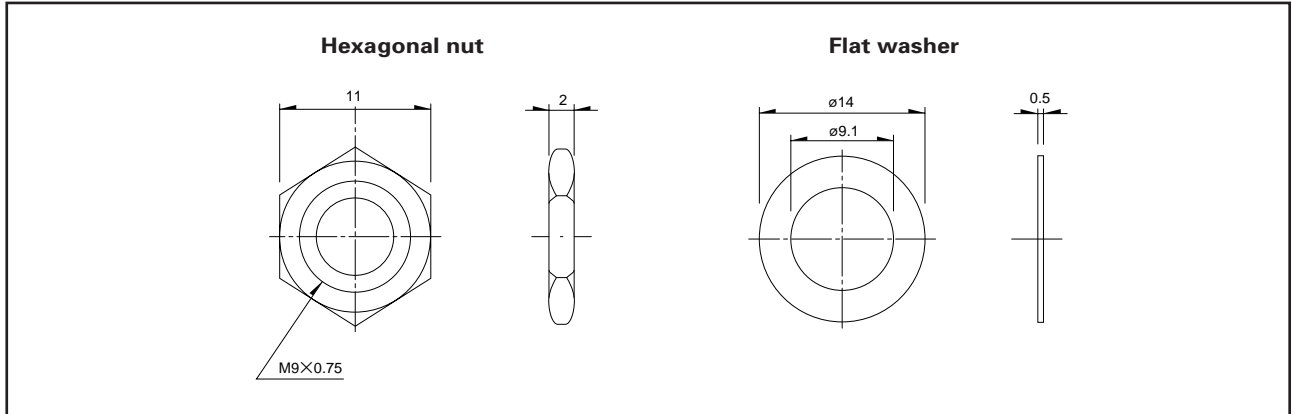

RK097, EC11B Series

Unit:mm

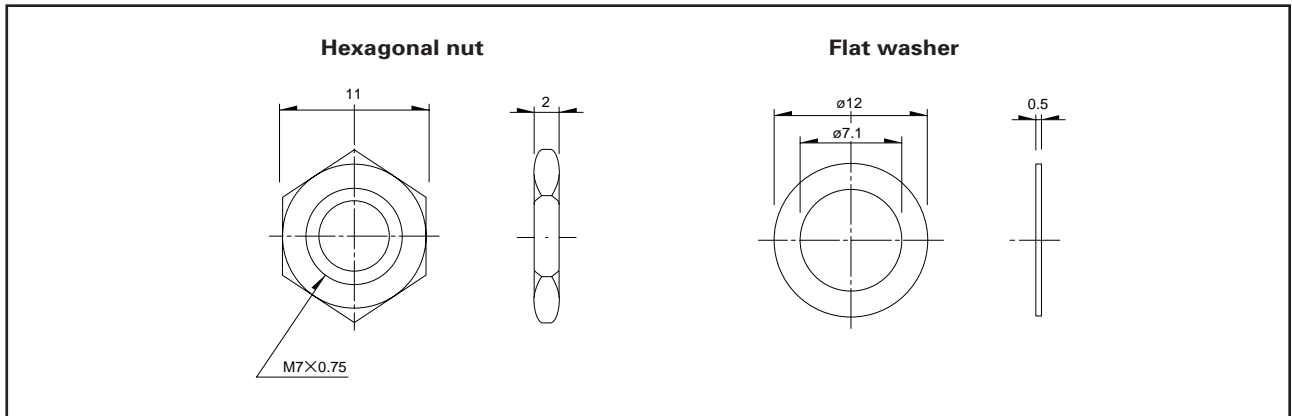

Detector

Push

Slide

Rotary

Encoders

Power

Dual-in-line
Package Type

Multi Control
Devices

TACT Switch™

Custom-
Products

Incremental
Type

Absolute
Type